



## City of Aurora Public Works Department

# PUBLIC IMPROVEMENT PERMIT INSTRUCTIONS

Permit Center • 15151 E. Alameda Parkway, Ste 2400 • Aurora, CO 80012  
303.739.7420 • Email: [pipermits@auroragov.org](mailto:pipermits@auroragov.org)

Occupancy Fees are charged for any work impacting the public right of way. The Street Occupancy Fee will apply whenever any portion/lane of any public sidewalk, alley, or roadway must be closed as a result of construction, repair, utility, or other activity. The Street Occupancy Fee is connected to the physical length and duration in time of the closure, with adjustments for type of facility impacted. The published City Fee Schedule is online.

Any permits that will impact parking or the flow of vehicles, bicyclists, pedestrians, or other users of the public right of way will require submittal and approval of a traffic control plan (TCP) before the permit will be issued. This includes, but is not limited to, street cuts, sidewalk repair/replacement, dry utility access, lane closures, et al.

All traffic control plans (TCPs) must follow the requirements of the current Manual on Uniform Traffic Control Devices, which is available online at <http://mutcd.fhwa.dot.gov>. Generally, overnight closures are not permitted and work involving traffic control on Arterials or Collectors may only occur between the hours of 8:30am and 3:30pm. Local Roadway traffic control hours are typically 7am to 5pm. Special circumstances requiring exceptions to these general requirements will be evaluated on a case-by-case basis.

TCPs are required for emergency work as well as scheduled work—every effort will be made to expedite the review and approval of TCPs and permits for emergency work. The City will not be under any obligation to accept any work performed prior to approval of a TCP and/or issuance of a permit even if said work is performed to City standards.

It is the responsibility of the party performing the work to have a copy of the approved TCP: and permit on site at all times, and to conform to the approved TCP at all times.

The Street Occupancy Fee will be calculated based upon the information provided on the Traffic Control Plan (TCP) submitted to the City as part of the Public Improvement permit application process. The City provides a selection of TCP templates, found at the end of these instructions, for use on LOCAL streets and ALLEYS ONLY to assist in submittal of the required TCP and Street Occupancy Fee information: [Please see Street Map for street classification information.](#)

### **COLLECTOR and MAJOR/MINOR ARTERIAL**

Traffic Control Plans must be prepared specific to the work in question and include, at a minimum, the following information in addition to the appropriate traffic control devices necessary for the Traffic Control Plan(s) to be compliant with the most current edition of The Manual on Uniform Traffic Control Devices (MUTCD):

1. Permit applicant contact info- including: Company Name, Contact Person, Address, and Phone Number.
2. Location of Work Zone—street name affected and cross streets on each end of work zone.
3. Posted Speed Limit of the roadway(s) affected
4. Dimensions of the Work Zone-Length of where the actual work will be completed.
5. Taper Length-Taper length examples are included in the attachments to this document
6. Total Length of proposed closure each day- including all tapers/buffers/work zone (dimensions for these items shall also be indicated individually for proper review)
7. Classification of street impacted [Please see Street Map for street classification information.](#)
8. Duration of closure in days.
9. Number of lanes impacted/closed.
10. Proposed peak hour impact: Yes or No. Please note that Peak Hour is defined as 5:30am-8:30am and/or 3:30pm-6:30pm Mon-Fri, and that Peak Hour lane closures are not typically permitted on Arterials/Collectors within the City. Please also note that Overnight closures are also not typically permitted within the City.
11. Sidewalk closure: Yes or No. Predefined as 450ft for a typical city block. This fee does not apply for local roads.
12. Bike/Park lane closure: Yes or No. This fee does not apply for local roads.
13. Permit Parking: Yes or No.
14. Detour required: Yes or No. If yes, please see information below that applies to all streets.

## **DETOURS: ALL STREETS EXCEPT ALLEYS**

If the extent of your work and your traffic control generates the need for a vehicular detour, a separate detour plan shall be submitted as part of your overall TCP submittal. **In addition to** the appropriate traffic control devices necessary for the Traffic Control Plan(s) to be compliant with the Manual on Uniform Traffic Control Devices (MUTCD), the following information shall be indicated on the detour plan: number of lanes detoured; proposed duration of detour in days; if the detour is proposed to be present during peak hours (5:30am-8:30am and/or 3:30pm-6:30pm Mon-Fri). The Peak Hour Detour fee shall apply for any days for which the detour is proposed to be present during any portion of the peak hour period(s). The Off Peak Detour fee shall apply for any days for which the detour is not proposed to be present during any portion of the peak hours as defined above.

**By submitting any Traffic Control Plan, the applicant agrees to provide all traffic control devices indicated on the APPROVED TCP. Any discrepancy between the APPROVED TCP and field conditions (including duration in time) shall result in additional fees and/or work stoppage until corrected or paid.**

## **SAMPLE PLANS LOCAL and ALLEY (Not applicable to Arterial/Collector roads)**

### 1. TYPICAL SIDEWALK CLOSURE PLAN\*\*

\*\*Please note there is no street occupancy fee for a sidewalk closure on a local street but appropriate traffic control and a TCP must still be provided.

### 2. SHOULDER WORK WITH MINOR ENCROACHMENT

### 3A. NON – EMERGENCY LOCAL STREET CONTROL PLAN

### 3B. **EMERGENCY** LOCAL STREET CONTROL PLAN

### 4. TWO-WAY TRAFFIC WITH FLAGGERS

### 5. For Future TCP use.

### 6. ALLEY TRAFFIC CONTROL PLAN

### 7. CUL DE SAC TRAFFIC CONTROL PLAN

Sample plans are provided as a courtesy only. The City reserves the right to require any further information or modifications according to the City's engineering judgment. PLEASE NOTE THAT TCP SUBMITTALS ARE SUBJECT TO THE CURRENTLY APPLICABLE Traffic Control Plan Review Fee and that if a TCP is rejected, EACH RESUBMITTAL IS SUBJECT TO AN ADDITIONAL Re-Application Fee. Specific fee amounts can be found in the City's current published Fee Schedule, located here: [Click Here for Current Fee Schedule](#)



# CITY OF AURORA SAMPLE TRAFFIC CONTROL PLAN INFORMATION

## Temporary Traffic Control Spacing Tables revised 8/2010

Table 1

### Advance Sign Spacing within Warning Area

Posted Speed	Initial Sign	Additional Signs
0-30 mph	100 feet	100 feet
35-40 mph	350 feet	350 feet
45-55 mph	500 feet	500 feet

Signs on portable supports shall be at least one foot above the roadway.

Table 2

### Taper Length, Number of Devices, and Device Spacing Table

Use 12 Ft lane width as default unless otherwise approved

Posted Speed MPH	Min. Merging Taper length (L) Lane Width (W) in Feet			Minimum Number of Devices Lane Width in Feet			Maximum Device Spacing in Feet		Buffer Space
	10	11	12	10	11	12	Along Taper	Along Tangent	FT
25 or below	105	115	125	6	6	6	25	50	155
30	150	165	180	6	7	7	30	60	200
35	205	225	245	7	8	8	35	70	250
40	270	295	320	8	9	9	40	80	305
45	450	495	540	11	12	13	45	90	360
50	500	550	600	11	12	13	50	100	425
55	550	605	660	11	12	13	55	110	495
60	600	660	720	11	12	13	60	120	570
65	650	715	780	11	12	13	65	130	645

**Flagger Taper = 100' Maximum    Shifting Taper = 1/2 L    Shoulder Taper = 1/3 L    Bike Lane Taper = 50'**

For more information consult  
Manual on Uniform Traffic Control Devices 2009 Edition



City of Aurora Public Works Department

**CONTRACTOR INFORMATION**

Permit Center • 15151 E. Alameda Parkway, Ste 2400 • Aurora, CO 80012  
303.739.7420 • Email: pipermits@auroragov.org

TCP CONTRACTOR INFORMATION (REQUIRED)

STREET NAME \_\_\_\_\_

BETWEEN \_\_\_\_\_

AND \_\_\_\_\_

TYPE OF ROADWAY \_\_\_\_\_

DURATION OF CLOSURE \_\_\_\_\_  
(IN DAYS)

START DATE \_\_\_\_\_

# OF LANES CLOSED \_\_\_\_\_

SIDEWALK CLOSED        Y        N

METERED PARKING        Y        N

POSTED SPEED LIMIT \_\_\_\_\_

(C) WORK ZONE DIMENSIONS  
(INCLUDE AREA FOR VEHICLES)

LENGTH (FT.) \_\_\_\_\_ WIDTH (FT.) \_\_\_\_\_

(B) TAPER LENGTH \_\_\_\_\_

(A) TOTAL CLOSURE LENGTH \_\_\_\_\_  
(B) BEGIN TAPER + (C) WZ LENGTH + END TAPER

(D) WORK ZONE ADDRESS

(E) INDICATE NORTH

APPLICANT AGREES TO PROVIDE ALL TRAFFIC CONTROL DEVICES INDICATED ON THIS TAFFIC CONTROL PLAN (TCP) CONSISTENT WITH THE APPROVED TCP. CLOSURE IMPACT TO TRAFFIC OTHER THAN 8:30A TO 3:30P M-F MUST BE APPROVED BY THE TRAFFIC MANAGER. ANY DISCREPANCY BETWEEN APPROVED TCP AND FIELD CONDITIONS (INCLUDING DURATION), MAY RESULT IN ADDITIONAL FEES AND/OR WORK STOPPAGE UNTIL CORRECTED OR PAID.

CONTRACTOR \_\_\_\_\_

CONTACT PERSON \_\_\_\_\_

CONTACT PHONE \_\_\_\_\_

EMAIL \_\_\_\_\_



# CITY OF AURORA SAMPLE TRAFFIC CONTROL PLAN TYPICAL SIDEWALK CLOSURE FOR LOCAL STREETS ONLY

TCP 1

### APPLICANT TO COMPLETE

STREET NAME \_\_\_\_\_

BETWEEN \_\_\_\_\_

AND \_\_\_\_\_

TYPE OF ROADWAY \_\_\_\_ Local \_\_\_\_\_

DURATION OF CLOSURE \_\_\_\_\_  
(IN DAYS)

START DATE \_\_\_\_\_

# OF LANES CLOSED \_\_ N/A \_\_\_\_\_

POSTED SPEED LIMIT \_\_\_\_ 25 MPH \_\_\_\_\_

(A) WORK ZONE DIMENSIONS  
(INCLUDE AREA FOR VEHICLES)

LENGTH (FT.) \_\_\_\_\_ WIDTH (FT.) \_\_\_\_\_

(B) TOTAL CLOSURE LENGTH \_\_\_\_\_  
BLOCK LENGTH

(C) WORK ZONE ADDRESS \_\_\_\_\_

(D) INDICATE NORTH

APPLICANT AGREES TO PROVIDE ALL TRAFFIC CONTROL DEVICES INDICATED ON THIS TRAFFIC CONTROL PLAN (TCP) CONSISTENT WITH THE APPROVED TCP. ANY DISCREPANCY BETWEEN APPROVED TCP AND FIELD CONDITIONS (INCLUDING DURATION) MAY RESULT IN ADDITIONAL FEES AND/OR WORK STOPPAGE UNTIL CORRECTED OR PAID.

CONTRACTOR \_\_\_\_\_

CONTACT PERSON \_\_\_\_\_

CONTACT PHONE \_\_\_\_\_

EMAIL \_\_\_\_\_

ALL TRAFFIC CONTROL DEVICES SHALL CONFORM TO THE CURRENT M.U.T.C.D.

THE CITY OF AURORA RESERVES THE RIGHT TO REQUIRE ANY FURTHER INFORMATION OR MODIFICATIONS ACCORDING TO THE CITY'S ENGINEERING JUDGEMENT. REJECTED PLANS WILL BE SUBJECT TO AN ADDITIONAL FEE PER THE CURRENT FEE SCHEDULE.

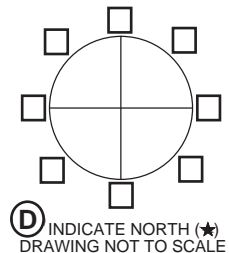
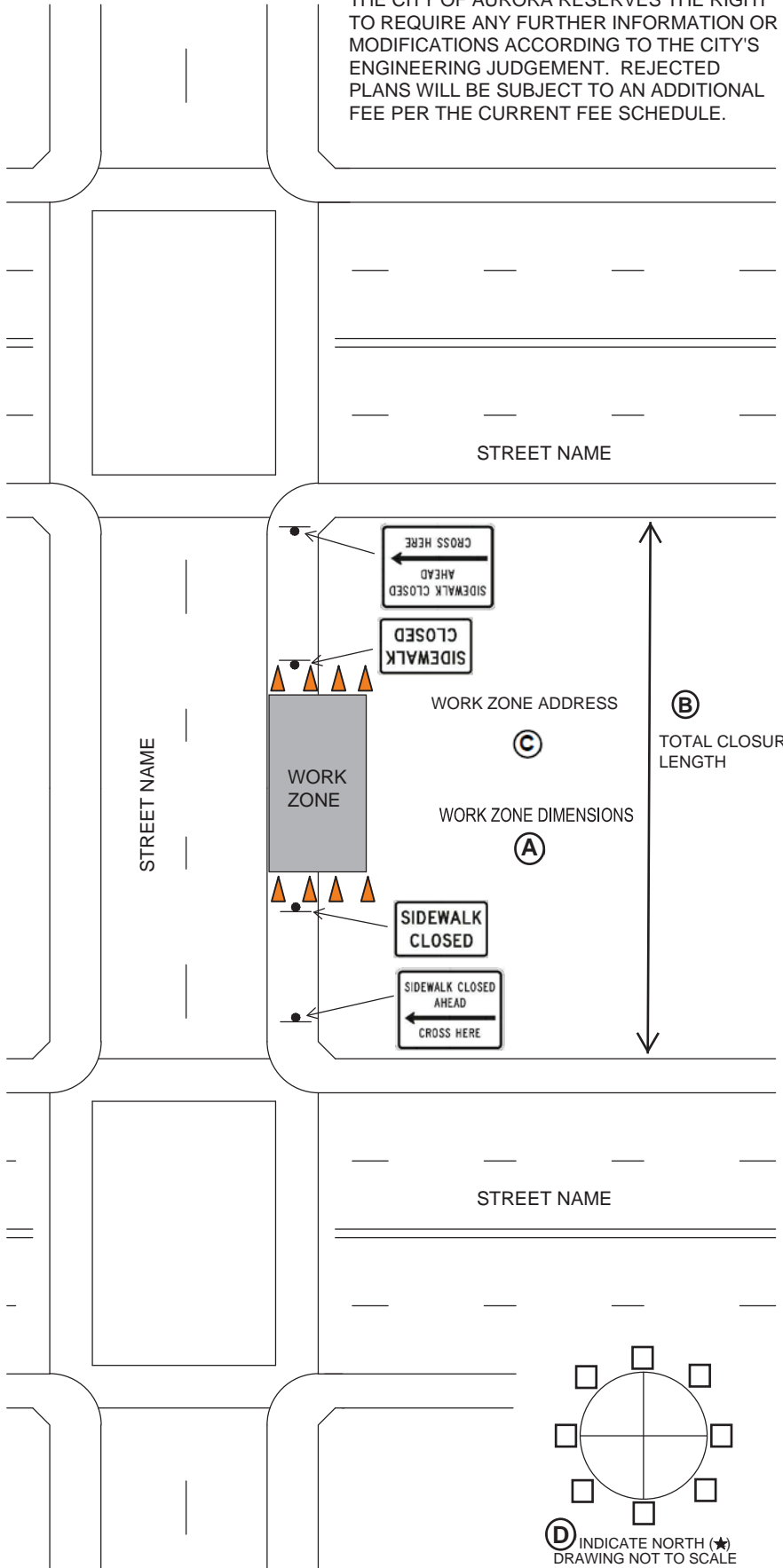

Sight distance shall be maintained at all public and private intersections and driveways. If sight distance is not achievable, prior approval by the City Traffic Engineer is required to either restrict turn movements or use flaggers and shall include coordination with the affected property/business owner(s).



# CITY OF AURORA SAMPLE TRAFFIC CONTROL PLAN

## WORK IN SHOULDER WITH MINOR ENCROACHMENT LOCAL STREETS ONLY

TCP 2

### APPLICANT TO COMPLETE

STREET NAME \_\_\_\_\_

BETWEEN \_\_\_\_\_

AND \_\_\_\_\_

TYPE OF ROADWAY Local

DURATION OF CLOSURE \_\_\_\_\_  
(IN DAYS)

START DATE \_\_\_\_\_

# OF LANES CLOSED 1

SIDEWALK CLOSURE    Y    N

METERED PARKING    Y    N

POSTED SPEED LIMIT 25 MPH

(A) WORK ZONE DIMENSIONS  
(INCLUDES AREA FOR VEHICLES)  
LENGTH (ft.) \_\_\_\_\_ WIDTH (ft.) \_\_\_\_\_

(B) TAPER LENGTH 45 Ft.

(C) TOTAL CLOSURE LENGTH \_\_\_\_\_  
( (B) SHOULDER TAPER + (C) WZ LENGTH )

(D) WORK ZONE ADDRESS \_\_\_\_\_

(E) INDICATE NORTH

APPLICANT AGREES TO PROVIDE ALL TRAFFIC CONTROL DEVICES INDICATED ON THIS TRAFFIC CONTROL PLAN (TCP) CONSISTENT WITH THE APPROVED TCP. ANY DISCREPANCY BETWEEN APPROVED TCP AND FIELD CONDITIONS (INCLUDING DURATION) MAY RESULT IN ADDITIONAL FEES AND/OR WORK STOPPAGE UNTIL CORRECTED OR PAID.

CONTRACTOR \_\_\_\_\_

CONTACT PERSON \_\_\_\_\_

CONTACT PHONE \_\_\_\_\_

EMAIL \_\_\_\_\_

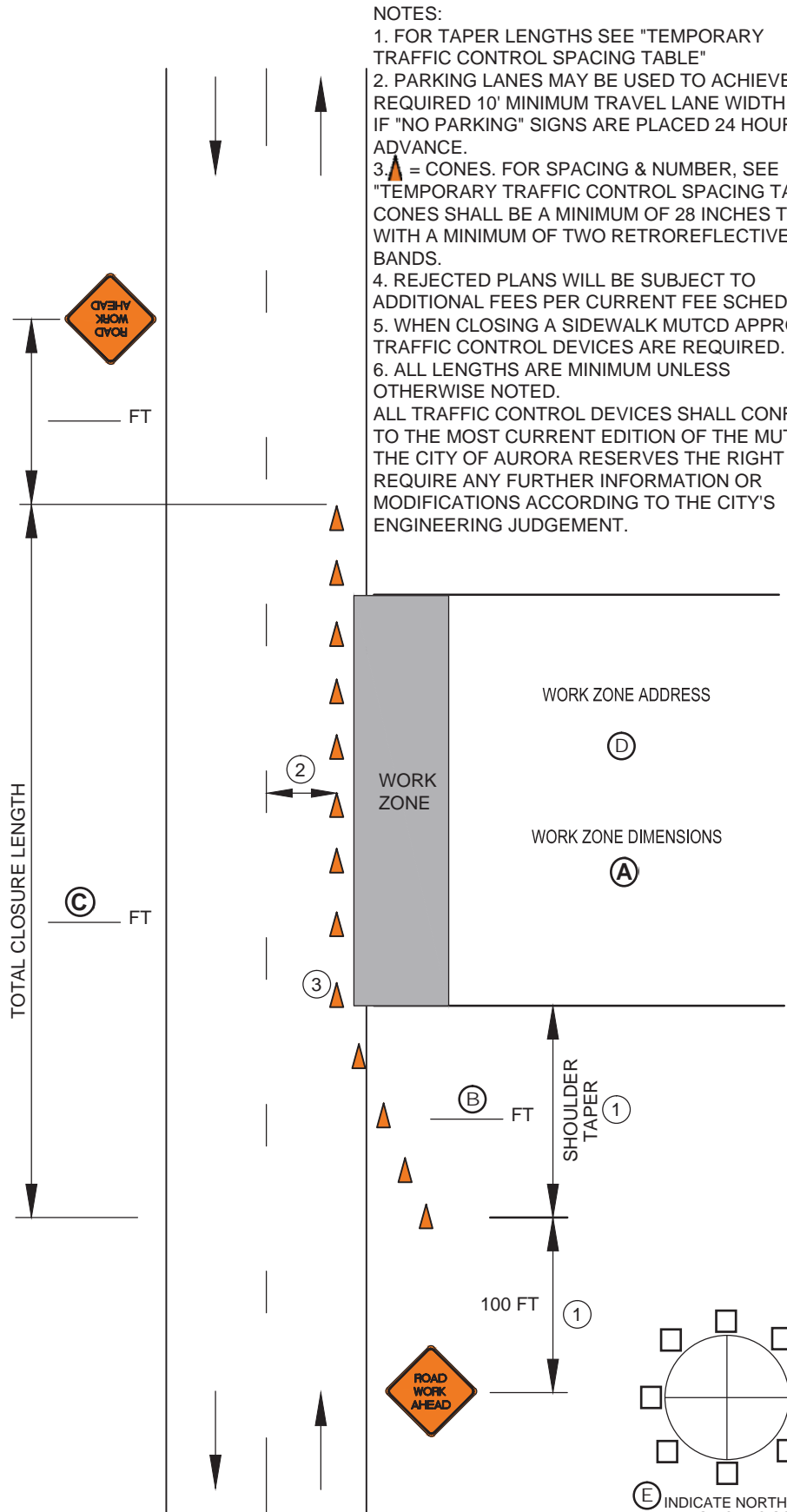

**NOTES:**

1. FOR TAPER LENGTHS SEE "TEMPORARY TRAFFIC CONTROL SPACING TABLE"
  2. PARKING LANES MAY BE USED TO ACHIEVE A REQUIRED 10' MINIMUM TRAVEL LANE WIDTH ONLY IF "NO PARKING" SIGNS ARE PLACED 24 HOURS IN ADVANCE.
  3. ▲ = CONES. FOR SPACING & NUMBER, SEE "TEMPORARY TRAFFIC CONTROL SPACING TABLE". CONES SHALL BE A MINIMUM OF 28 INCHES TALL WITH A MINIMUM OF TWO RETROREFLECTIVE BANDS.
  4. REJECTED PLANS WILL BE SUBJECT TO ADDITIONAL FEES PER CURRENT FEE SCHEDULE.
  5. WHEN CLOSING A SIDEWALK MUTCD APPROVED TRAFFIC CONTROL DEVICES ARE REQUIRED.
  6. ALL LENGTHS ARE MINIMUM UNLESS OTHERWISE NOTED.
- ALL TRAFFIC CONTROL DEVICES SHALL CONFORM TO THE MOST CURRENT EDITION OF THE MUTCD. THE CITY OF AURORA RESERVES THE RIGHT TO REQUIRE ANY FURTHER INFORMATION OR MODIFICATIONS ACCORDING TO THE CITY'S ENGINEERING JUDGEMENT.

Sight distance shall be maintained at all public and private intersections and driveways. If sight distance is not achievable, prior approval by the City Traffic Engineer is required to either restrict turn movements or use flaggers and shall include coordination with the affected property/business owner(s).



# CITY OF AURORA SAMPLE TRAFFIC CONTROL PLAN

## NON EMERGENCY - LOCAL STREET CONTROL PLAN

### WORK ZONE LENGTH $\text{C} < 150'$ - TWO WAY TRAFFIC

TCP 3A

#### APPLICANT TO COMPLETE

STREET NAME \_\_\_\_\_

BETWEEN \_\_\_\_\_

AND \_\_\_\_\_

TYPE OF ROADWAY Local

DURATION OF CLOSURE \_\_\_\_\_  
(IN DAYS)

START DATE \_\_\_\_\_

# OF LANES CLOSED 1

SIDEWALK CLOSED     Y     N

METERED PARKING     Y     N

POSTED SPEED LIMIT 25 MPH

(A) WORK ZONE DIMENSIONS  
(INCLUDE AREA FOR VEHICLES)

    LENGTH (FT.) \_\_\_\_\_ WIDTH (FT.) \_\_\_\_\_

(B) TAPER LENGTH (100' Max) \_\_\_\_\_

(C) TOTAL CLOSURE LENGTH \_\_\_\_\_  
(A) WZ LENGTH + (B) BEGIN TAPER + END TAPER

(D) WORK ZONE ADDRESS \_\_\_\_\_

(E) INDICATE NORTH \_\_\_\_\_

APPLICANT AGREES TO PROVIDE ALL TRAFFIC CONTROL DEVICES INDICATED ON THIS TRAFFIC CONTROL PLAN (TCP) CONSISTENT WITH THE APPROVED TCP. ANY DISCREPANCY BETWEEN APPROVED TCP AND FIELD CONDITIONS (INCLUDING DURATION) MAY RESULT IN ADDITIONAL FEES AND/OR WORK STOPPAGE UNTIL CORRECTED OR PAID.

CONTRACTOR \_\_\_\_\_

CONTACT PERSON \_\_\_\_\_

CONTACT PHONE \_\_\_\_\_

EMAIL \_\_\_\_\_

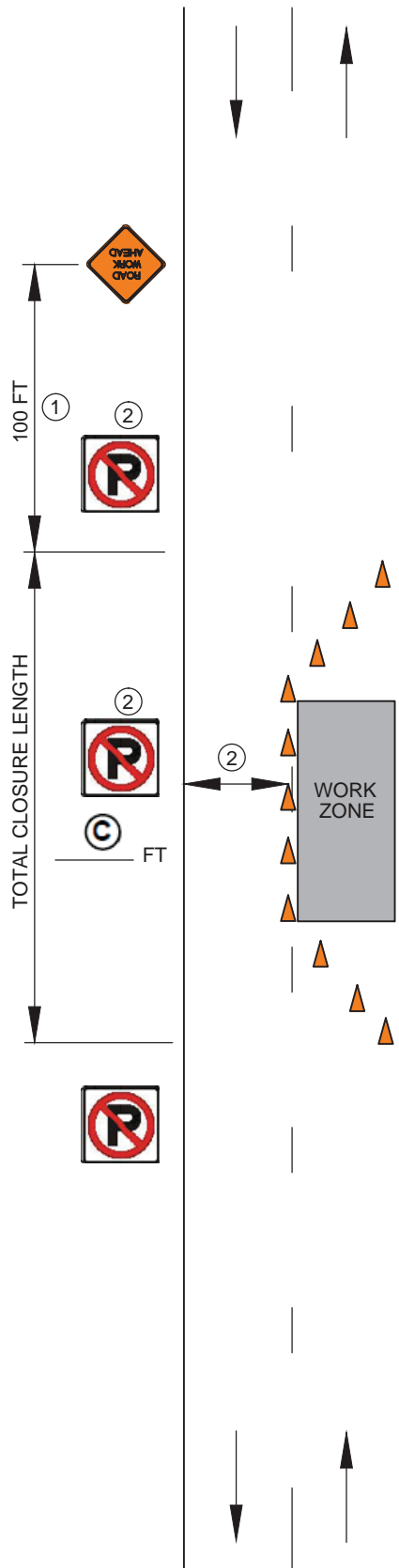

- NOTES:
- FOR SPACING DISTANCES SEE "TEMPORARY TRAFFIC CONTROL SPACING TABLE"
  - PARKING LANES MAY BE USED TO ACHIEVE A REQUIRED 10' MINIMUM TRAVEL LANE WIDTH ONLY IF "NO PARKING" SIGNS ARE PLACED 24 HOURS IN ADVANCE.
  - $\blacktriangle$  = CONES. FOR SPACING & NUMBER, SEE "TEMPORARY TRAFFIC CONTROL SPACING TABLE". CONES SHALL BE A MINIMUM OF 28 INCHES TALL WITH A MINIMUM OF TWO RETROREFLECTIVE BANDS.
  - REJECTED PLANS WILL BE SUBJECT TO ADDITIONAL FEES PER CURRENT FEE SCHEDULE.
  - WHEN CLOSING A SIDEWALK MUTCD APPROVED TRAFFIC CONTROL DEVICES ARE REQUIRED.
  - ALL LENGTHS ARE MINIMUM UNLESS OTHERWISE NOTED.
- ALL TRAFFIC CONTROL DEVICES SHALL CONFORM TO THE MOST CURRENT EDITION OF THE MUTCD. THE CITY OF AURORA RESERVES THE RIGHT TO REQUIRE ANY FURTHER INFORMATION OR MODIFICATIONS ACCORDING TO THE CITY'S ENGINEERING JUDGEMENT.

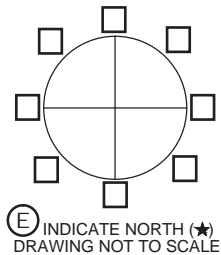

Sight distance shall be maintained at all public and private intersections and driveways. If sight distance is not achievable, prior approval by the City Traffic Engineer is required to either restrict turn movements or use flaggers and shall include coordination with the affected property/business owner(s).



# CITY OF AURORA SAMPLE TRAFFIC CONTROL PLAN

## EMERGENCY - LOCAL STREET CONTROL PLAN

### WORK ZONE LENGTH $\text{C} < 150'$ - TWO WAY TRAFFIC

TCP 3B

#### APPLICANT TO COMPLETE

STREET NAME \_\_\_\_\_

BETWEEN \_\_\_\_\_

AND \_\_\_\_\_

TYPE OF ROADWAY Local

DURATION OF CLOSURE \_\_\_\_\_  
(IN DAYS)

START DATE \_\_\_\_\_

# OF LANES CLOSED 1

SIDEWALK CLOSED     Y     N

METERED PARKING     Y     N

POSTED SPEED LIMIT 25 MPH

(A) WORK ZONE DIMENSIONS  
(INCLUDE AREA FOR VEHICLES)

LENGTH (FT.) \_\_\_\_\_ WIDTH (FT.) \_\_\_\_\_

(B) TAPER LENGTH (100' max.) \_\_\_\_\_

(C) TOTAL CLOSURE LENGTH \_\_\_\_\_  
(A) WZ LENGTH + (B) BEGIN TAPER + END TAPER

(D) WORK ZONE ADDRESS \_\_\_\_\_

(E) INDICATE NORTH \_\_\_\_\_

APPLICANT AGREES TO PROVIDE ALL TRAFFIC CONTROL DEVICES INDICATED ON THIS TRAFFIC CONTROL PLAN (TCP) CONSISTENT WITH THE APPROVED TCP. ANY DISCREPANCY BETWEEN APPROVED TCP AND FIELD CONDITIONS (INCLUDING DURATION) MAY RESULT IN ADDITIONAL FEES AND/OR WORK STOPPAGE UNTIL CORRECTED OR PAID.

CONTRACTOR \_\_\_\_\_

CONTACT PERSON \_\_\_\_\_

CONTACT PHONE \_\_\_\_\_

EMAIL \_\_\_\_\_

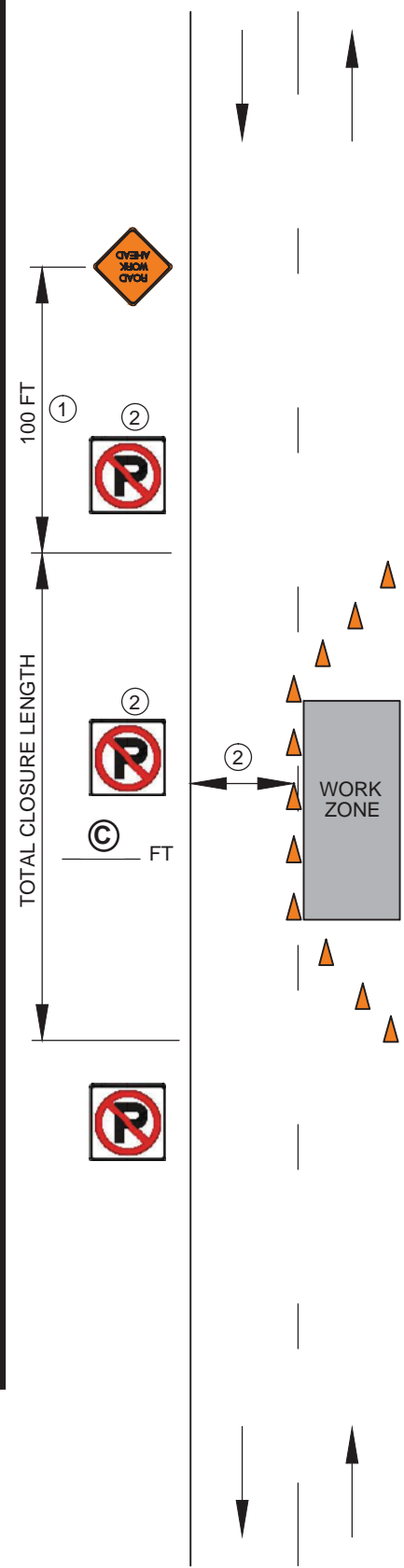

- NOTES:
1. FOR SPACING DISTANCES SEE "TEMPORARY TRAFFIC CONTROL SPACING TABLE"
  2. PARKING LANES MAY BE USED TO ACHIEVE A REQUIRED 10' MINIMUM TRAVEL LANE WIDTH ONLY IF "NO PARKING" SIGNS ARE PLACED 24 HOURS IN ADVANCE.
  3. = CONES. FOR SPACING & NUMBER, SEE "TEMPORARY TRAFFIC CONTROL SPACING TABLE". CONES SHALL BE A MINIMUM OF 28 INCHES TALL WITH A MINIMUM OF TWO RETROREFLECTIVE BANDS.
  4. REJECTED PLANS WILL BE SUBJECT TO ADDITIONAL FEES PER CURRENT FEE SCHEDULE.
  5. WHEN CLOSING A SIDEWALK MUTCD APPROVED TRAFFIC CONTROL DEVICES ARE REQUIRED.
  6. ALL LENGTHS ARE MINIMUM UNLESS OTHERWISE NOTED.
- ALL TRAFFIC CONTROL DEVICES SHALL CONFORM TO THE MOST CURRENT EDITION OF THE MUTCD. THE CITY OF AURORA RESERVES THE RIGHT TO REQUIRE ANY FURTHER INFORMATION OR MODIFICATIONS ACCORDING TO THE CITY'S ENGINEERING JUDGEMENT.

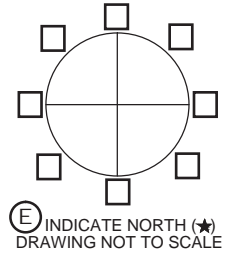

Sight distance shall be maintained at all public and private intersections and driveways. If sight distance is not achievable, prior approval by the City Traffic Engineer is required to either restrict turn movements or use flaggers and shall include coordination with the affected property/business owner(s).





# CITY OF AURORA SAMPLE TRAFFIC CONTROL PLAN

## TWO-WAY TRAFFIC WITH FLAGGERS - WORK ZONE LENGTH $\text{C} \geq 150'$

### APPLIES TO LOCAL STREETS ONLY

TCP 4

#### APPLICANT TO COMPLETE

STREET NAME \_\_\_\_\_

BETWEEN \_\_\_\_\_

AND \_\_\_\_\_

TYPE OF ROADWAY Local

DURATION OF CLOSURE \_\_\_\_\_  
(IN DAYS)

START DATE \_\_\_\_\_

# OF LANES CLOSED 1

SIDEWALK CLOSED    Y    N

METERED PARKING    Y    N

POSTED SPEED LIMIT 25 MPH

(A) WORK ZONE DIMENSIONS  
(INCLUDE AREA FOR VEHICLES)

LENGTH (FT.) \_\_\_\_\_ WIDTH (FT.) \_\_\_\_\_

(B) TAPER LENGTH (100' max.) \_\_\_\_\_

(C) TOTAL CLOSURE LENGTH \_\_\_\_\_  
(A) WZ LENGTH + (B) FLAGGER TAPER + FLAGGER TAPER

(D) WORK ZONE ADDRESS \_\_\_\_\_

(E) INDICATE NORTH \_\_\_\_\_

APPLICANT AGREES TO PROVIDE ALL TRAFFIC CONTROL DEVICES INDICATED ON THIS TRAFFIC CONTROL PLAN (TCP) CONSISTENT WITH THE APPROVED TCP. ANY DISCREPANCY BETWEEN APPROVED TCP AND FIELD CONDITIONS (INCLUDING DURATION) MAY RESULT IN ADDITIONAL FEES AND/OR WORK STOPPAGE UNTIL CORRECTED OR PAID.

CONTRACTOR \_\_\_\_\_

CONTACT PERSON \_\_\_\_\_

CONTACT PHONE \_\_\_\_\_

EMAIL \_\_\_\_\_

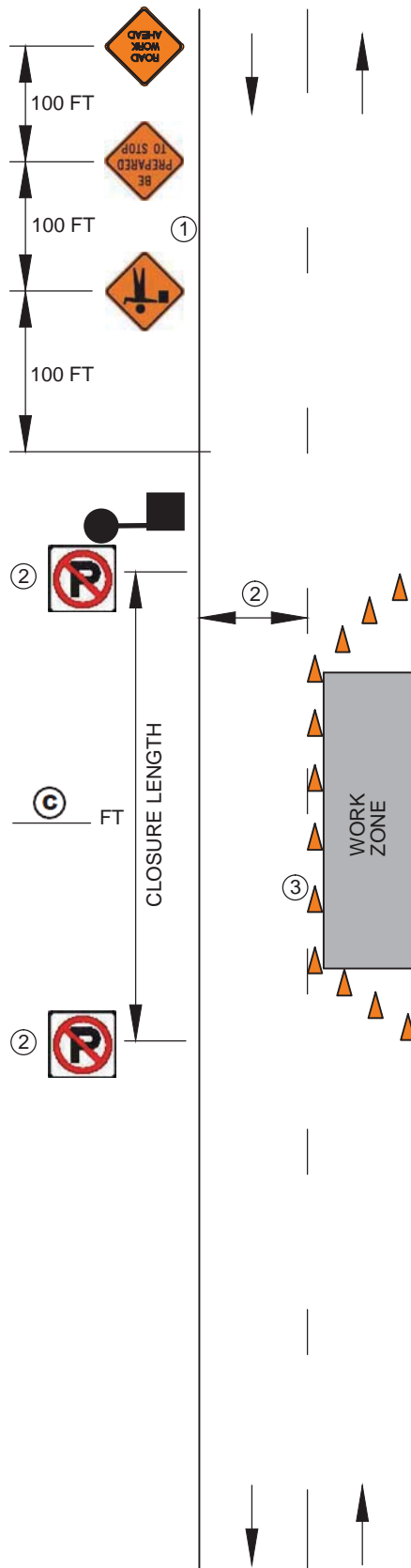

**NOTES:**

1. FOR SPACING DISTANCES SEE "TEMPORARY TRAFFIC CONTROL SPACING TABLE"
  2. PARKING LANES MAY BE USED TO ACHIEVE A REQUIRED 10' MINIMUM TRAVEL LANE WIDTH ONLY IF "NO PARKING" SIGNS ARE PLACED 24 HOURS IN ADVANCE.
  3. = CONES. FOR SPACING & NUMBER, SEE "TEMPORARY TRAFFIC CONTROL SPACING TABLE". CONES SHALL BE A MINIMUM OF 28 INCHES TALL WITH A MINIMUM OF TWO RETROREFLECTIVE BANDS.
  4. REJECTED PLANS WILL BE SUBJECT TO ADDITIONAL FEES PER CURRENT FEE SCHEDULE.
  5. WHEN CLOSING A SIDEWALK MUTCD APPROVED TRAFFIC CONTROL DEVICES ARE REQUIRED.
  6. ALL LENGTHS ARE MINIMUM UNLESS OTHERWISE NOTED.
- ALL TRAFFIC CONTROL DEVICES SHALL CONFORM TO THE MOST CURRENT EDITION OF THE MUTCD. THE CITY OF AURORA RESERVES THE RIGHT TO REQUIRE ANY FURTHER INFORMATION OR MODIFICATIONS ACCORDING TO THE CITY'S ENGINEERING JUDGEMENT.
- = FLAGGER WITH STOP/SLOW PADDLE

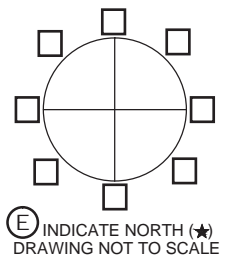
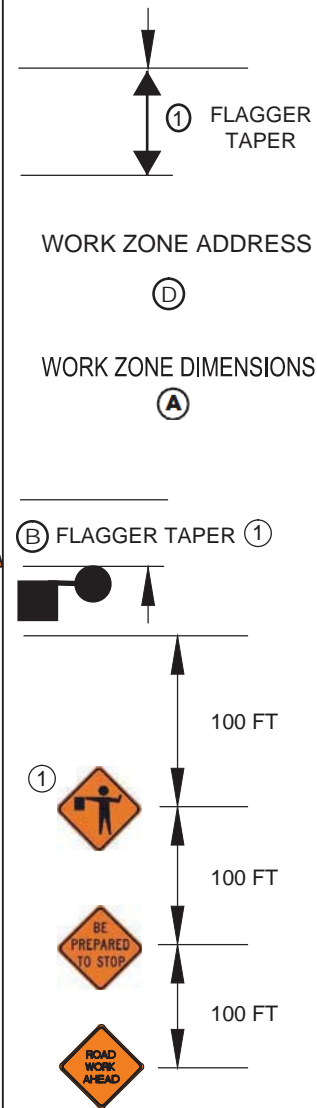

Sight distance shall be maintained at all public and private intersections and driveways. If sight distance is not achievable, prior approval by the City Traffic Engineer is required to either restrict turn movements or use flaggers and shall include coordination with the affected property/business owner(s).



# CITY OF AURORA SAMPLE TRAFFIC CONTROL PLAN ALLEY CLOSURE PLAN

TCP 6

### APPLICANT TO COMPLETE

STREET NAME \_\_\_\_\_

BETWEEN \_\_\_\_\_

AND \_\_\_\_\_

TYPE OF ROADWAY \_\_\_ Local \_\_\_\_\_

DURATION OF CLOSURE \_\_\_\_\_  
(IN DAYS)

START DATE \_\_\_\_\_

# OF LANES CLOSED \_\_\_\_\_

POSTED SPEED LIMIT \_ N/A \_\_\_\_\_

(A) WORK ZONE DIMENSIONS  
(INCLUDE AREA FOR VEHICLES)

LENGTH (FT.) \_\_\_\_\_ WIDTH (FT.) \_\_\_\_\_

(B) TOTAL CLOSURE LENGTH \_\_\_\_\_  
ALLEY LENGTH

(C) WORK ZONE ADDRESS \_\_\_\_\_

(D) INDICATE NORTH

APPLICANT AGREES TO PROVIDE ALL TRAFFIC CONTROL DEVICES INDICATED ON THIS TRAFFIC CONTROL PLAN (TCP) CONSISTENT WITH THE APPROVED TCP. ANY DISCREPANCY BETWEEN APPROVED TCP AND FIELD CONDITIONS (INCLUDING DURATION) MAY RESULT IN ADDITIONAL FEES AND/OR WORK STOPPAGE UNTIL CORRECTED OR PAID.

CONTRACTOR \_\_\_\_\_

CONTACT PERSON \_\_\_\_\_

CONTACT PHONE \_\_\_\_\_

EMAIL \_\_\_\_\_

TOTAL CLOSURE LENGTH

(B)



- NOTES:
- ① REJECTED PLANS WILL BE SUBJECT TO ADDITIONAL FEES PER CURRENT FEE SCHEDULE.
  - ② CONES MAY BE USED TO CLOSE OFF THE SIDEWALK IF NEEDED.

ALL TRAFFIC CONTROL DEVICES SHALL CONFORM TO THE CURRENT MUTCD.

THE CITY OF AURORA RESERVES THE RIGHT TO REQUIRE ANY FURTHER INFORMATION OR MODIFICATIONS ACCORDING TO THE CITY'S ENGINEERING JUDGMENT.

WORK ZONE DIMENSIONS:

(A)

WORK ZONE ADDRESS

(C)

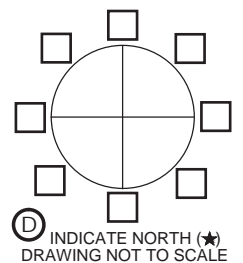



# CITY OF AURORA SAMPLE TRAFFIC CONTROL PLAN CUL-DE-SAC

TCP 7

## APPLICANT TO COMPLETE

STREET NAME \_\_\_\_\_

BETWEEN \_\_\_\_\_

AND \_\_\_\_\_

TYPE OF ROADWAY \_\_\_ Local \_\_\_\_\_

DURATION OF CLOSURE \_\_\_\_\_  
(IN DAYS)

START DATE \_\_\_\_\_

# OF LANES CLOSED \_\_\_\_\_

SIDEWALK CLOSED     Y     N

METERED PARKING     Y     N

POSTED SPEED LIMIT \_\_\_ 25 MPH \_\_\_\_\_

(A) WORK ZONE DIMENSIONS  
(INCLUDE AREA FOR VEHICLES)

LENGTH (FT.) \_\_\_\_\_ WIDTH (FT.) \_\_\_\_\_

TOTAL CLOSURE LENGTH \_\_\_\_\_  
(A) WZ LENGTH + TAPER LENGTH

(B) WORK ZONE ADDRESS \_\_\_\_\_

(C) INDICATE NORTH

APPLICANT AGREES TO PROVIDE ALL TRAFFIC CONTROL DEVICES INDICATED ON THIS TRAFFIC CONTROL PLAN (TCP) CONSISTENT WITH THE APPROVED TCP. ANY DISCREPANCY BETWEEN APPROVED TCP AND FIELD CONDITIONS (INCLUDING DURATION) MAY RESULT IN ADDITIONAL FEES AND/OR WORK STOPPAGE UNTIL CORRECTED OR PAID.

CONTRACTOR \_\_\_\_\_

\_\_\_\_\_

CONTACT PERSON \_\_\_\_\_

CONTACT PHONE \_\_\_\_\_

EMAIL \_\_\_\_\_

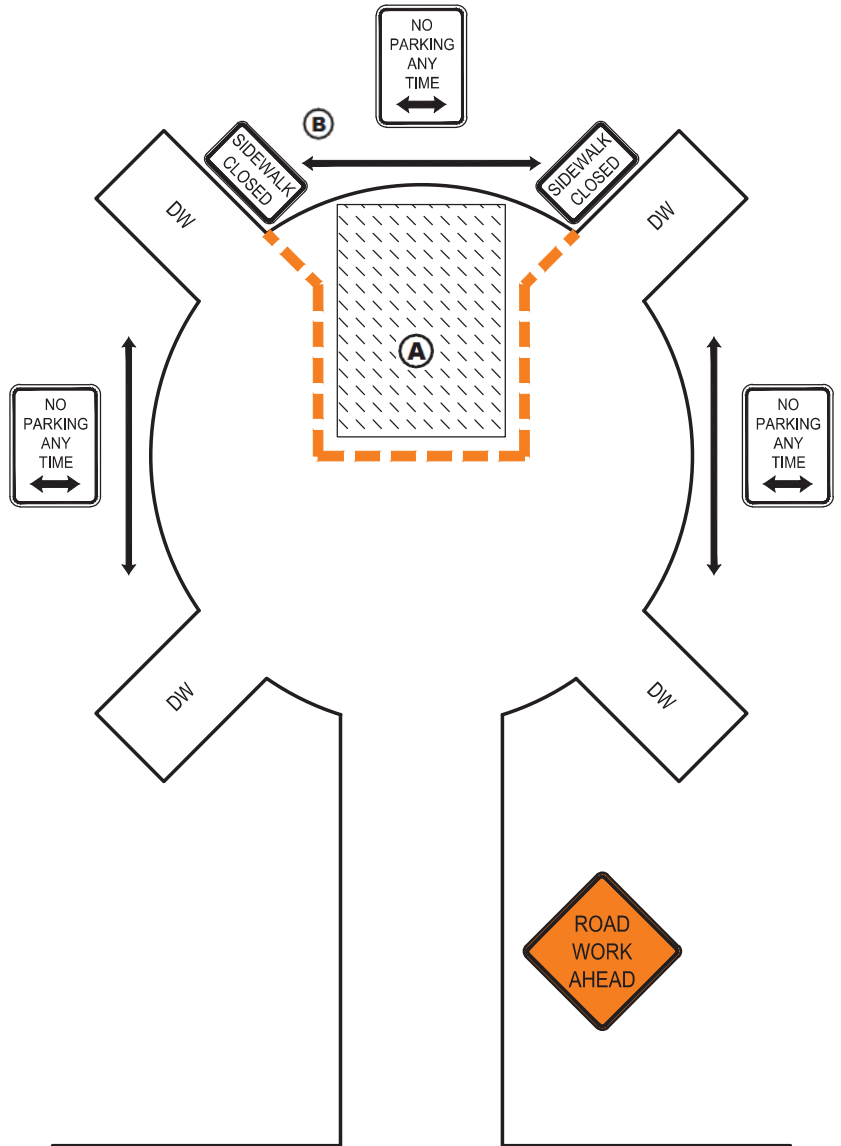

### NOTES:

1. REJECTED PLANS WILL BE SUBJECT TO ADDITIONAL FEES PER CURRENT FEE SCHEDULE.
2. CONES MAY BE USED TO CLOSE OFF THE SIDEWALK IF NEEDED.

ALL TRAFFIC CONTROL DEVICES SHALL CONFORM TO THE CURRENT MUTCD

THE CITY OF AURORA RESERVES THE RIGHT TO REQUIRE ANY FURTHER INFORMATION OR MODIFICATIONS ACCORDING TO THE CITY'S ENGINEERING JUDGEMENT

